

JASON[®]

HYDROTHERAPY

8328 MacArthur Dr. • North Little Rock, AR 72118
 501.771.4477 • Fax: 501.771.2333
 Customer Service: 800.255.5766
 www.jasoninternational.com

Designer Collection Specifications

ES553

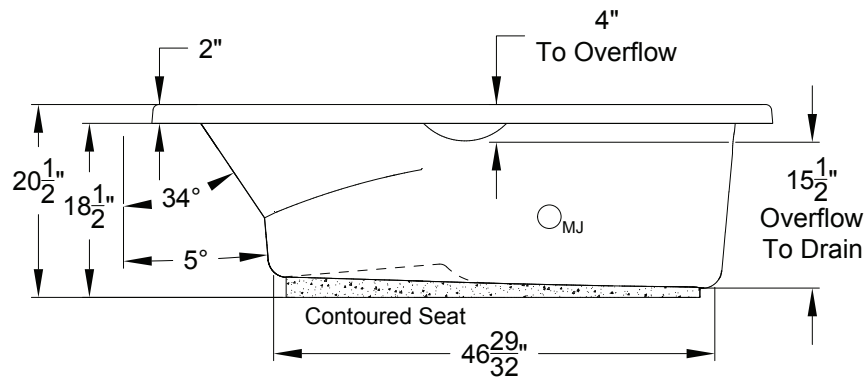
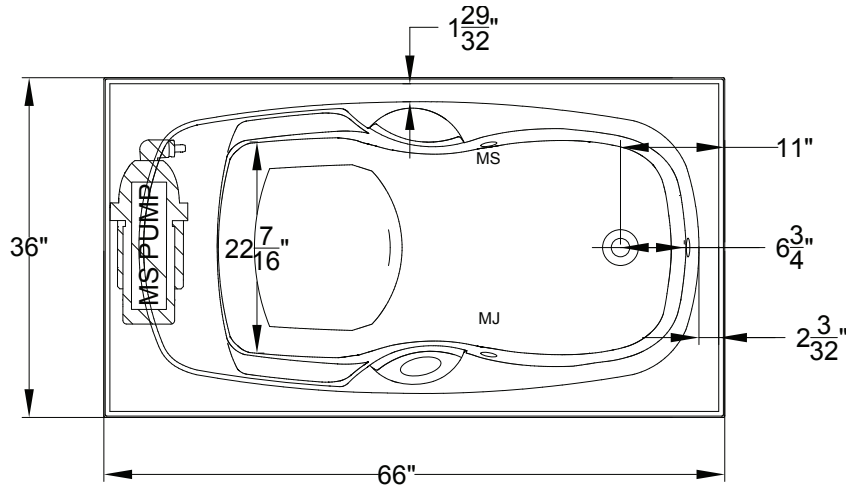

MicroSilk[®]



Patents received or pending.

Note: Dimensional Tolerances: ±1/4"

Drop-in-Hole Size:	64" x 34"
Operating Capacity:	47 Gal.
Overflow Capacity:	67 Gal.
Floor Loading / sq.ft.:	50.4 lbs.
Carton Weight:	124 lbs.
Cube:	34.3 ft. ³

Standard		A 120V system that includes a MicroSilk [®] unit, an electronic control, and a 20-minute timer.
Premier		A 120V system that includes a MicroSilk [®] unit; (2) Chromatherapy mood lights; Automatic Ozone System; an electronic control; and a 20-minute timer.
Signature		A 120V system that includes a MicroSilk [®] unit; (2) Chromatherapy mood lights; Automatic Ozone System, a digital control with LCD display; low water level and temperature sensors; enhanced user control options, a 20-minute timer; and Bluetooth Sound Immersion System. Control keypad controls the MicroSilk [®] unit, LED Chromatherapy mood lights, and shows equipment status, water temperature, and time remaining.

Construction: Fiberglass reinforced acrylic bath with Level Form[™] full-support base.

We provide products listed with Intertek ETL SEMKO (Edison Testing Laboratories) U.S. and Canadian and with International Association of Plumbing and Mechanical Officials (IAPMO). Consult factory with your listing requirements.